



LC3

MUSIC LAB

Operation Guide

Yamaha LC3 Operation Guide

Contents	Page
Controlling the Volume of the Teacher's Speaking Voice (Microphone)	1
Controlling the Teacher's Instrument Volume Level	1
Selecting Students	2
Interacting With a Single Student	4
Listening to a Single Student	4
Broadcasting a Single Student for the Entire Class	5
Addressing and Isolating All Students Simultaneously	6
Allowing the Entire Class to Interact	7
Quickly Resetting All Buttons	8
Muting All Student Instruments	8
Setting Students In PAIRS	9
Interacting with a PAIR	9
Grouping Students	10
Storing Custom Settings (RECALL MEMORY)	13
Recalling Custom Settings	14
Using a CD or MP3 Player	15
Recording a Student's Performance (Audio)	16
Using External Powered Speakers	16
Using the AUX Input	17

Controlling the Volume of the Teacher's Speaking Voice (Microphone)

With the MIC button on, move the MIC slider up to the desired voice level.

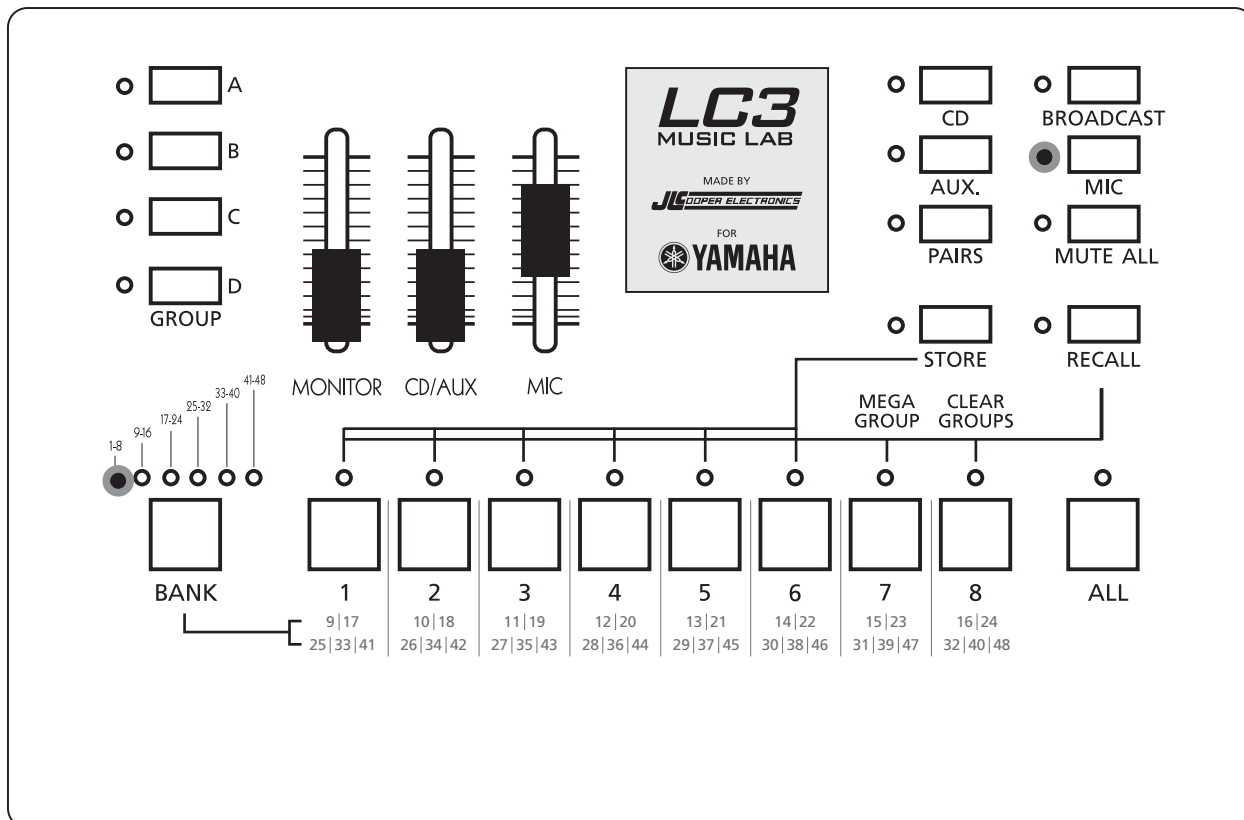

Controlling Teacher's Instrument Volume Level

Use the built-in volume control on your instrument to raise or lower its volume in the LC3 lab. It's the only instrument volume control you need be concerned with.

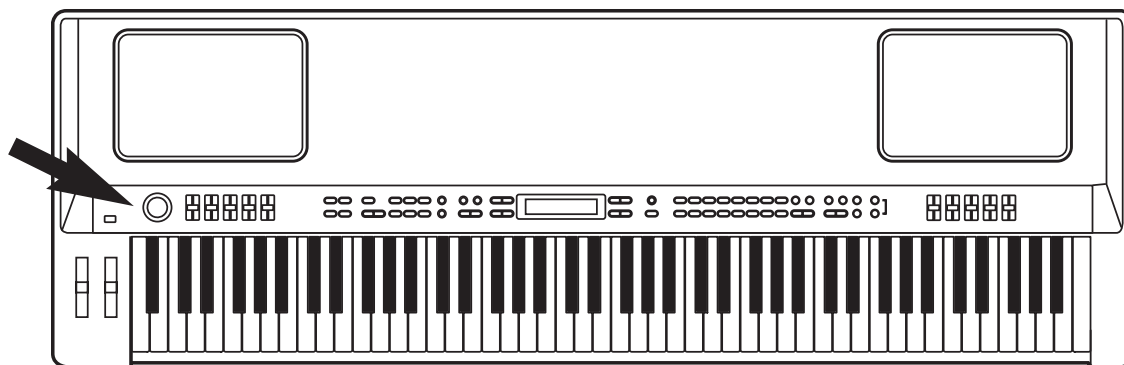

Volume knob on Yamaha CP300

Selecting Students

A BANK light will always be on no matter how many students are in the LC3 lab. The light will show the bank of students 1-8 at the bottom of the control unit. A fully expanded LC3 system will have a total of six banks (48 students). Each bank has eight students organized in the following fashion:

BANK 1-8

BANK 9-16

BANK 17-24

BANK 25-32

BANK 33-40

BANK 41-48

Not all LC3s will have all banks available. It depends on the number of expansion cards installed on the system. For LC3s with less than all expansion cards installed, the BANK select button will only cycle through banks installed in the system. It then returns to the first bank and cycles through again. Labs with no expansion cards will be locked on BANK 1-8.

Teachers of larger, expanded labs will find themselves jumping through banks quite frequently since they can only view the status of eight students at a time. For example, to confirm that students 3 and 13 are together, toggle between Bank 1-8 and 9-16 using the BANK button.

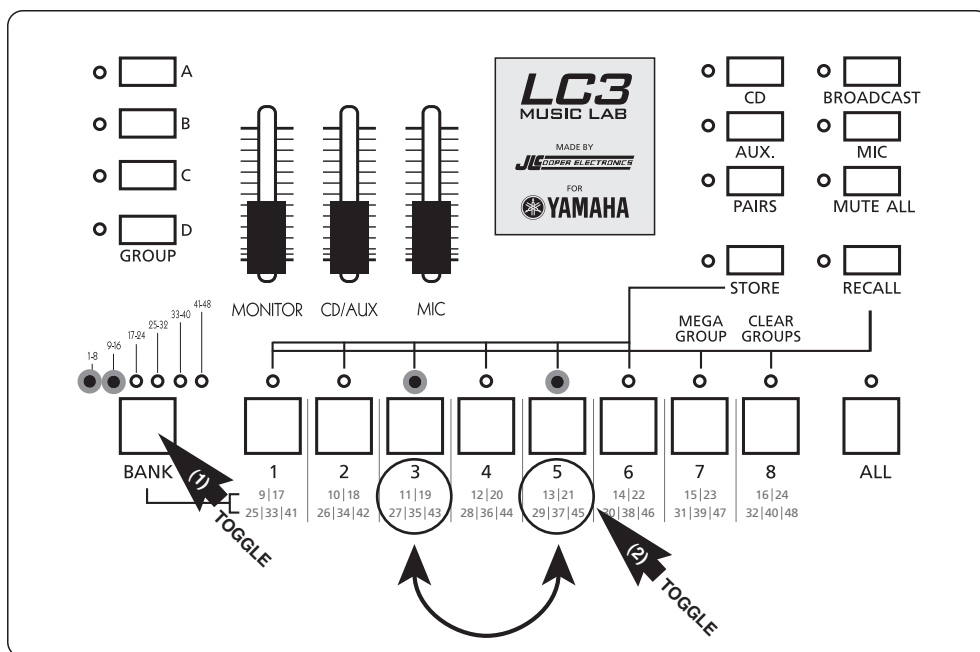

A handy table of numbers is printed on the control unit to help you quickly find the buttons of students in the various BANKS. For example, button 6 enables students 6, 14, 22, 30, 38, and 46 depending on the currently selected BANK.

Example One

When listening to student 3, the BANK button would be set where the first light (1-8) is lit and student button 3 would be on.

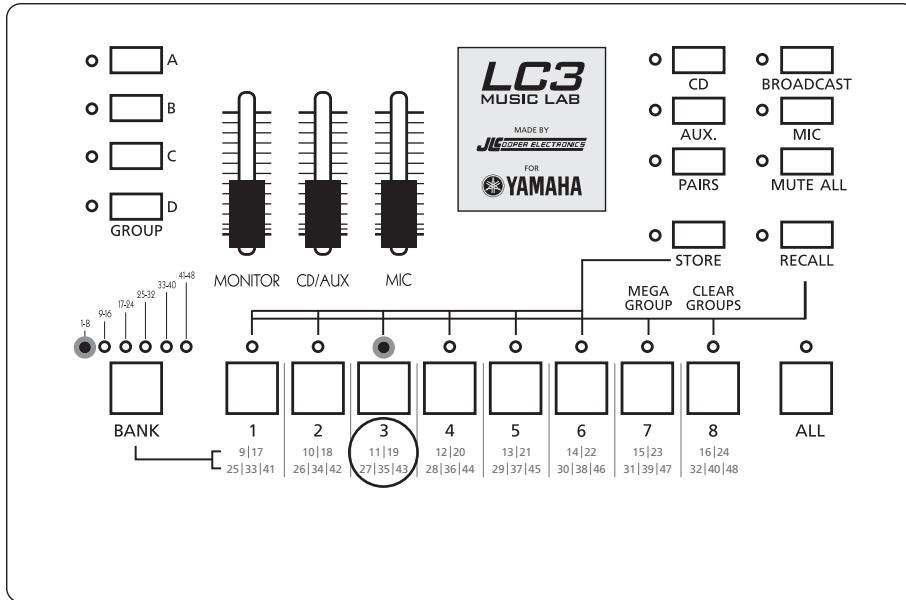

Example Two

To listen to student 10, press the BANK button until the second light is lit (signifying BANK 9-16). Then, press button number two for student 10.

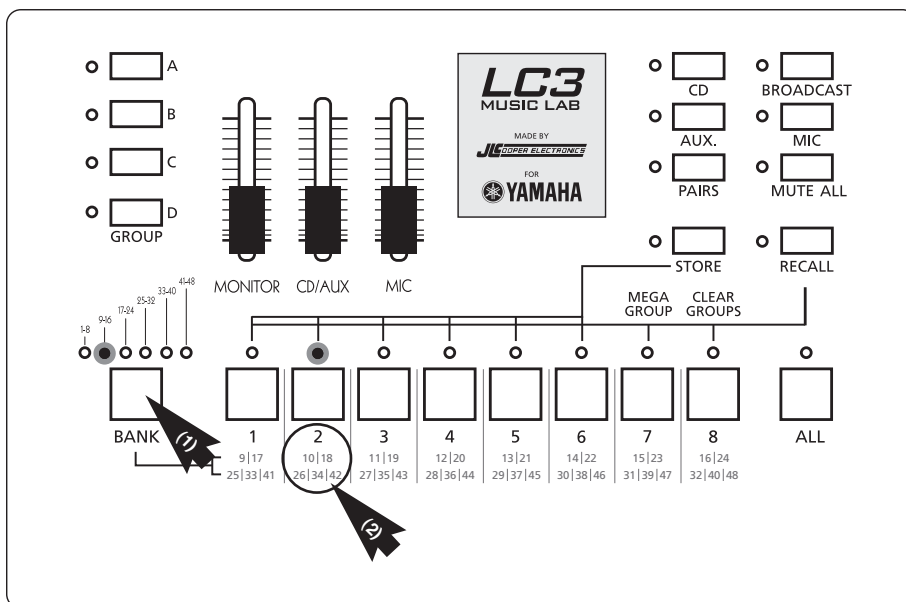

Interacting With a Single Student

This is essentially paying a visit to a student's virtual practice room. Once in the correct bank, select the student button and then turn on the MIC button. Think of turning on the MIC button as opening the practice room door. Make sure your MIC volume is up by using the MIC slider. When you're ready to leave this student's practice room, press the lit student button to turn it off.

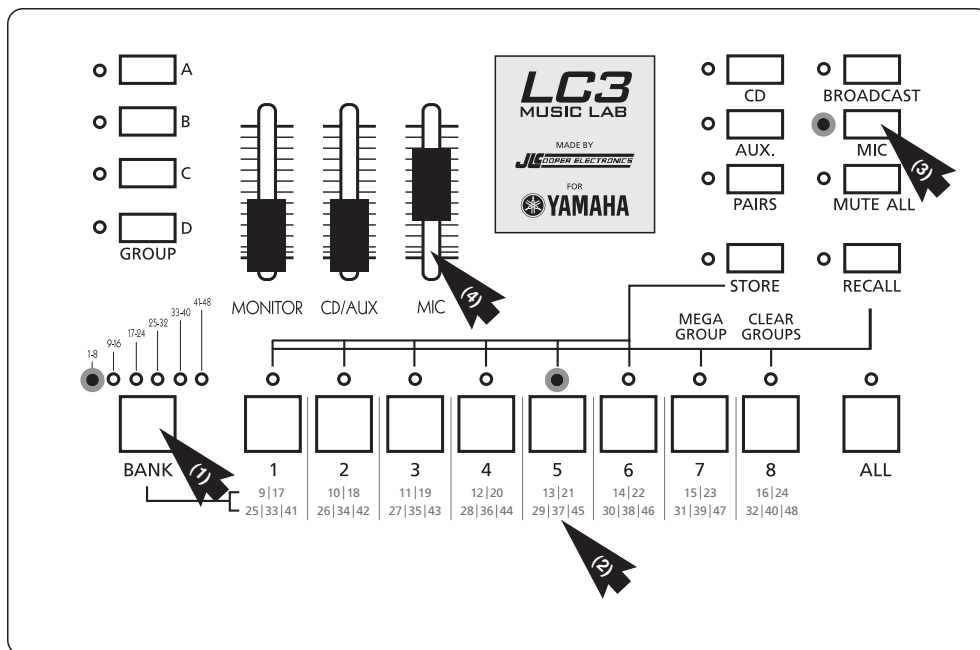

In this example, you are interacting with student 5.

Listening to a Single Student

If you want to listen in on a student without talking to them, the equivalent of putting your ear to the door, do not select the MIC button. You will know a student is selected when the light above their number is on. When the MIC button light is not on, the student can not hear you speak.

Broadcasting a Single Student for the Entire Class

Select a student as if you were going to work with them, then turn on the BROADCAST button. The selected student's performance will be heard by entire class.

To exit this mode, effectively sending all students back to their virtual practice rooms, turn BROADCAST off by touching the student button again.

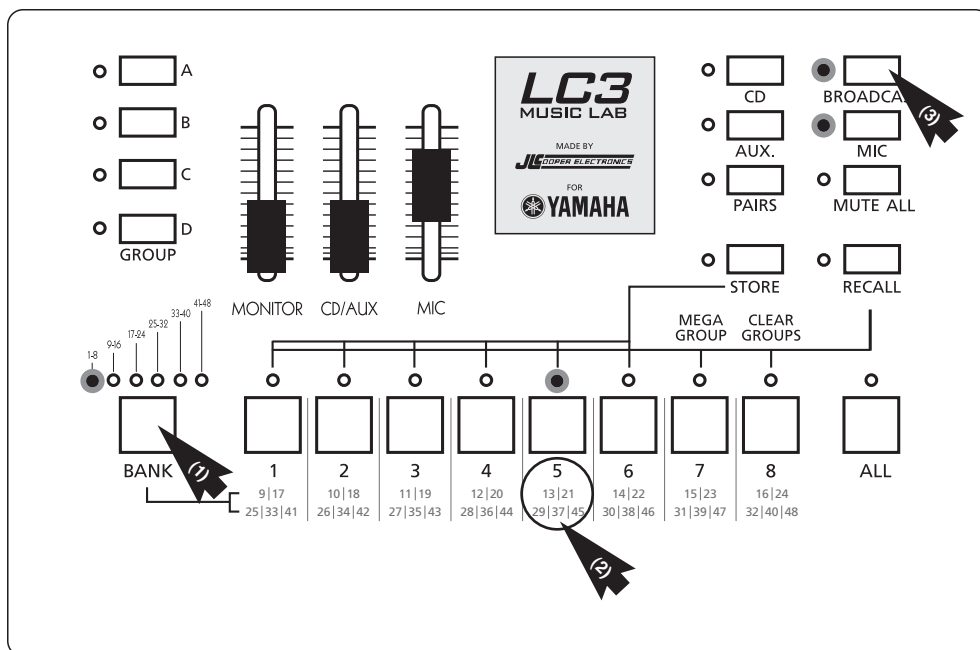

In this example, student 5 is playing for the class; you can make comments with MIC on.

Addressing and Isolating All Students Simultaneously

To speak to and play for all students without hearing their instruments, and without them being able to hear each other, press the ALL button (the MIC will come on automatically). The students will not be able to hear each other speak or play but they will hear their own instruments. This is the key difference of engaging the ALL button versus switching on every student button (in every Bank). The latter would have the students interacting with each other. Engaging ALL is like visiting each and every student in their virtual practice room at the same time... and the students never leave their rooms. To cancel this mode, press the ALL button so its light turns off.

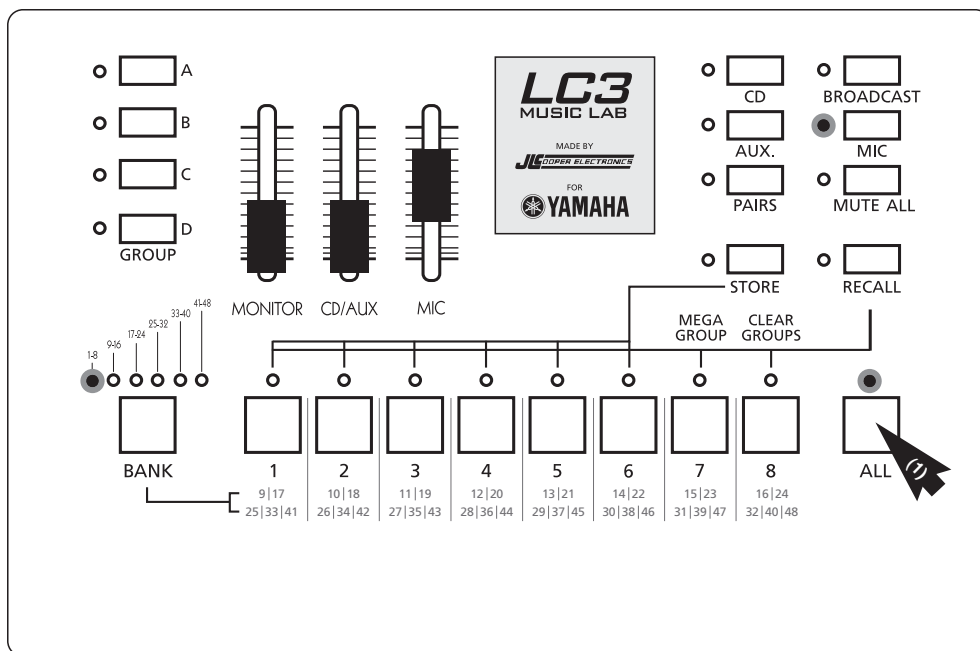

Allowing the Entire Class to Interact... the MEGAGROUP

This is essentially your “all together now” mode. You can hear students, students can hear you, and students can hear each other speak and play. In a simple 8-student (non-expanded) lab, this can be as simple as turning on student buttons 1, 2, 3, 4, 5, 6, 7 and 8. But in an expanded lab this would have to be done for each bank. Yamaha has created a handy shortcut to get all student buttons on or off quickly. RECALL MEMORY 7 and RECALL MEMORY 8 are reserved for these important tasks.* Simply tap (don't hold) the RECALL button and then tap student button 7 to activate all student buttons as a MEGAGROUP. This one action engages every student button across all banks. You will know your lab is in this mode by seeing every student light on, the MIC light on, and the GROUP A button flashing. To clear the MEGAGROUP, sending all students back to their virtual practice rooms, tap the RECALL button and then tap student button 8.

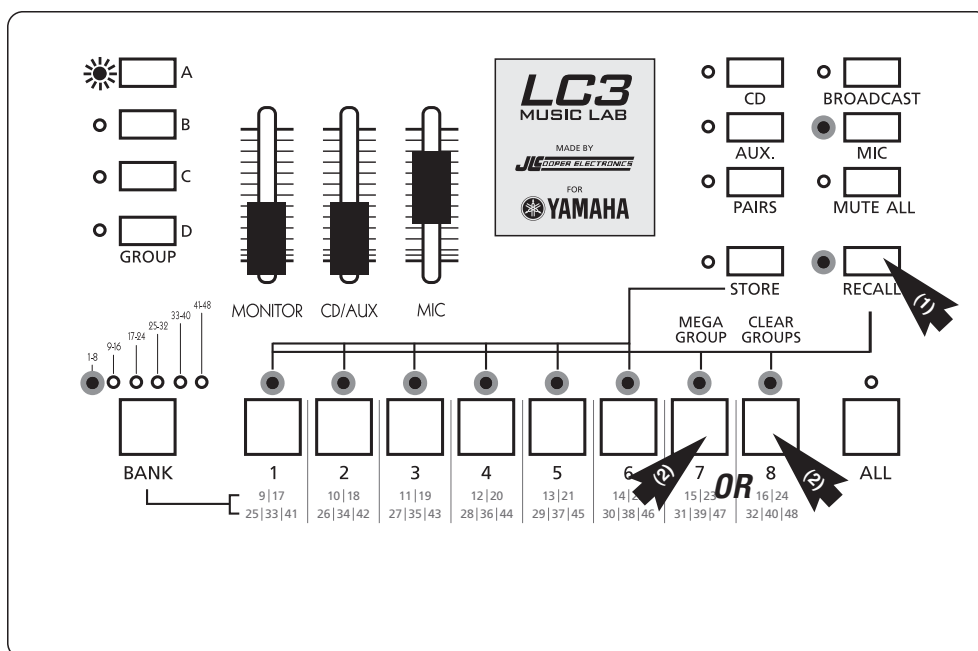

*Learn more about RECALL MEMORY on pages 13-14.

Quickly Resetting All Buttons

If you're unsure about which settings/buttons are on or off, press and hold the MUTE ALL button and then tap the ALL button. This resets all of the controller's student unit buttons to off. This is the same as turning the power off and then on again without making a trip to the power button on the hub.

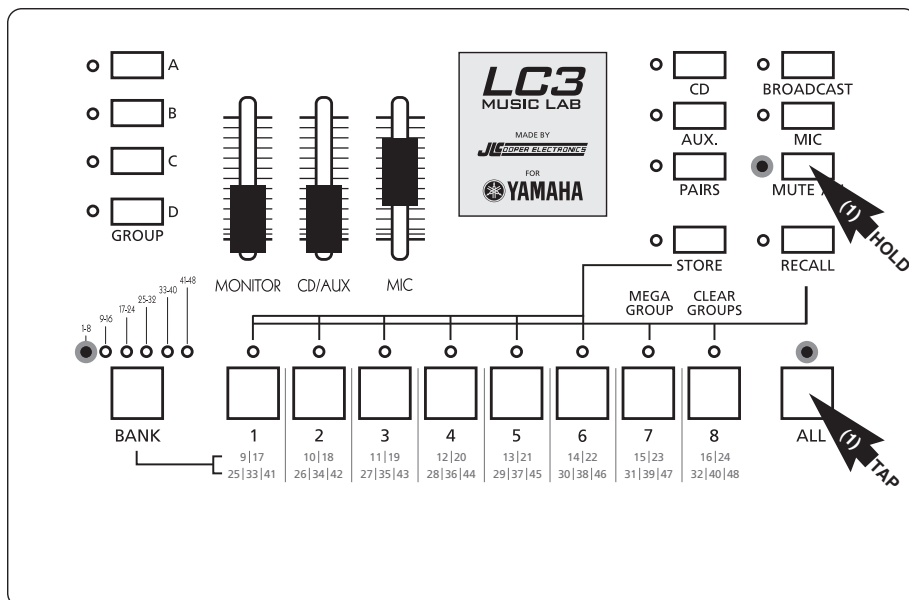

Muting All Student Instruments

When it's time for students to pay attention, temporarily disable their instruments by turning the MUTE ALL button on. *Note: student MICs are active but reduced in volume.*

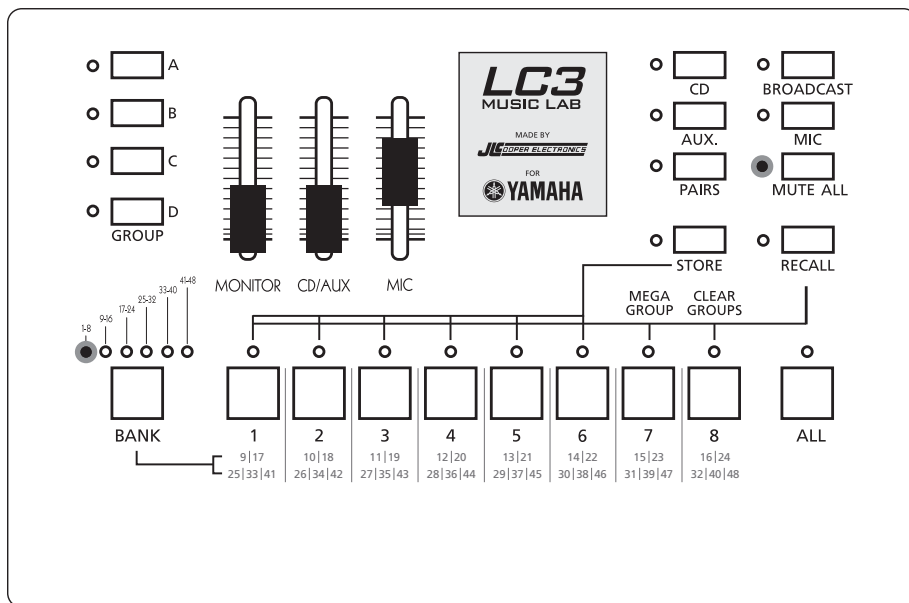

Setting Students In PAIRS

To quickly get students working in simple pairs (two students per virtual practice room), press the PAIRS button. This will automatically place student 1 with 2, 3 with 4, 5 with 6, etc.

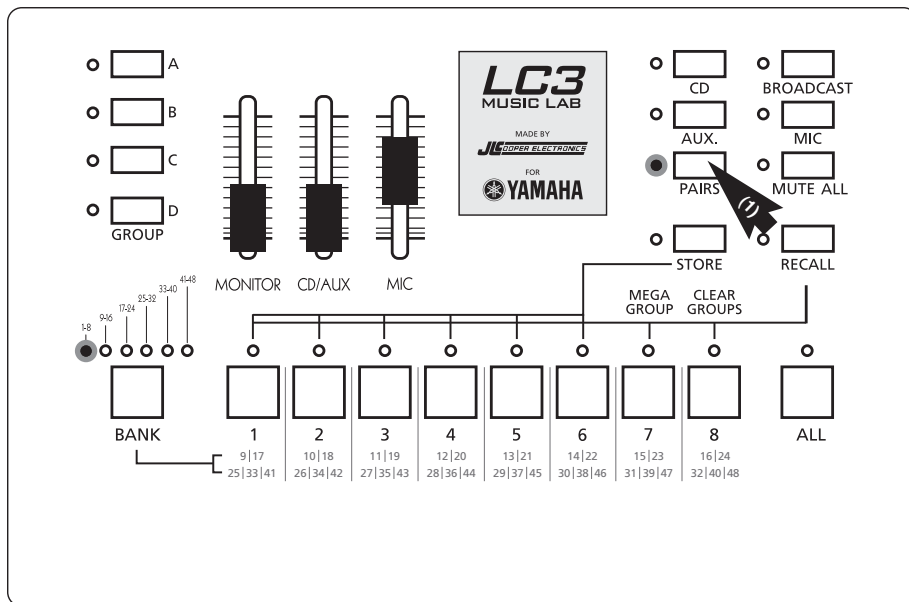

Interacting with a PAIR

With the PAIRS button on, press the student selector button of either member of a pair and turn on MIC. Notice that both lights turn on with a single button press. Work with pairs exactly as you would with individual students.

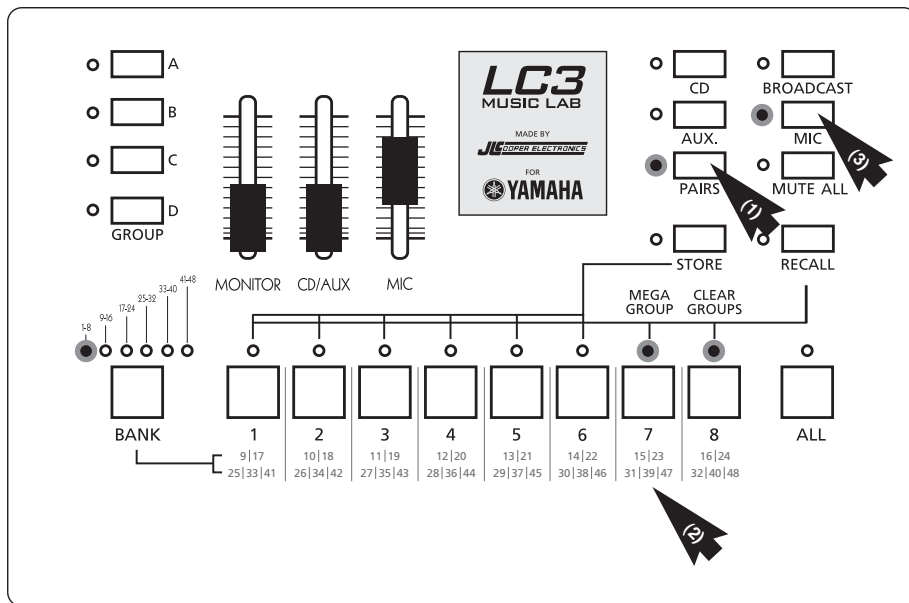

In this example, students 7 and 8 make up a pair.

Grouping Students

If simply pairing students isn't flexible enough for your needs, the LC3 Lab allows you to create easily recallable Groups. Think of a Group as a kind of virtual practice room in which multiple students can meet at the same time. You can have as many as four Groups (A/B/C/D) set up in the Controller at any given time. To group a set of students, press and hold GROUP button A, B, C or D as desired, select the BANK for the student(s) desired, and turn on the appropriate student buttons for that Group. Students from different banks may be grouped together in any combination within the four available Groups.

A flashing light next to Group button A, B, C or D indicates that the teacher is currently working with that Group. A steady light next to button A, B, C and D indicates that the Group is active and working with each other but without the teacher.

Keep in mind that RECALL MEMORY 7 and RECALL MEMORY 8 are factory pre-set Groups for engaging and clearing. RECALL MEMORY 7 sets up GROUP A with all student buttons on... a MEGAGROUP (Groups B/C/D are empty in this memory). RECALL MEMORY 8 has all four Groups empty of students. To create this clean slate as a starting point for building Groups, simply tap the RECALL button and then tap student button 8.

Example One

To set students 1, 3, 7 and 8 into a Group, press and hold GROUP button A, select BANK 1-8, press student 1 then 3 then 7 then 8. Release the GROUP button A and it will begin to flash, indicating the Group is active and the teacher is with them. To speak with the Group, turn on the MIC button.

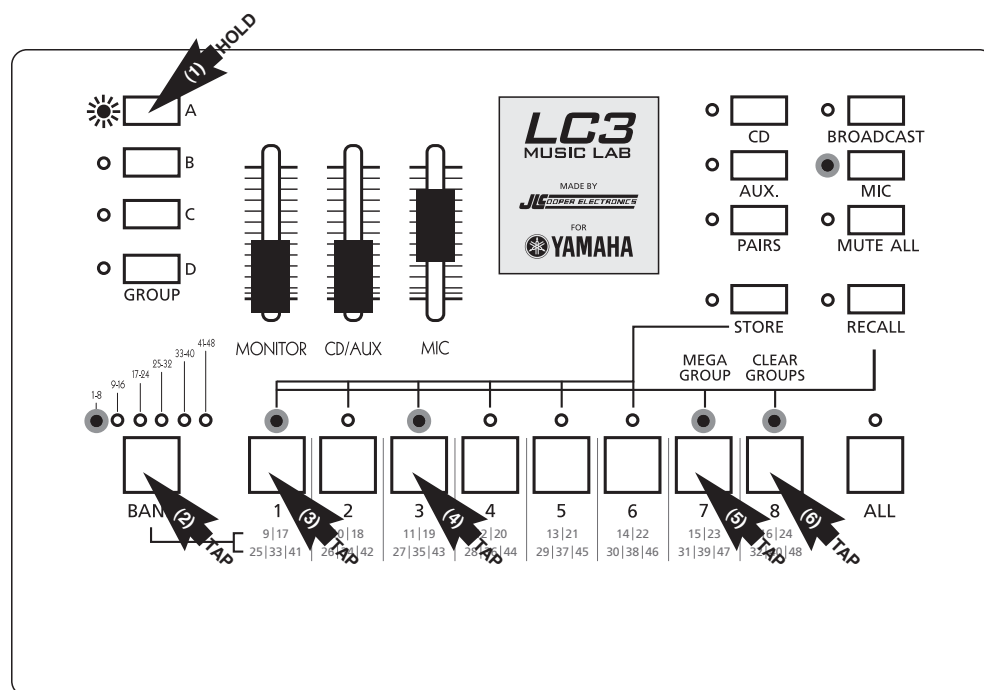

Example Two

Students 1, 3, 5 and 7 are Group A, students 2, 4, 6 and 8 are Group B, students 9, 10, 11 and 12 are Group C, and students 13, 14, 15 and 16 are Group D. In the illustration below, you are working with GROUP A, which has a flashing light. Groups B, C and D are working by themselves.

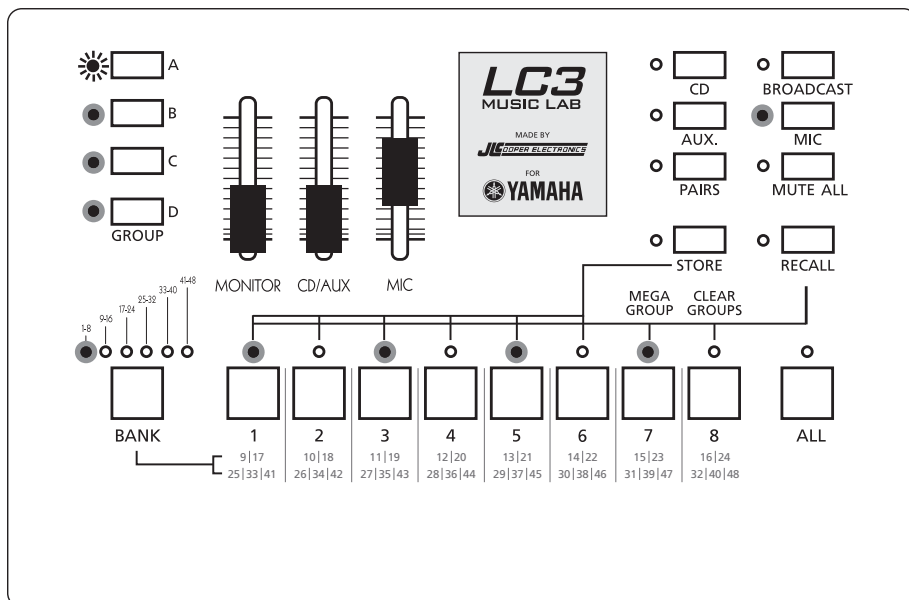

Example Three

You are working with GROUP B, which has a flashing light. A, C and D are working by themselves.

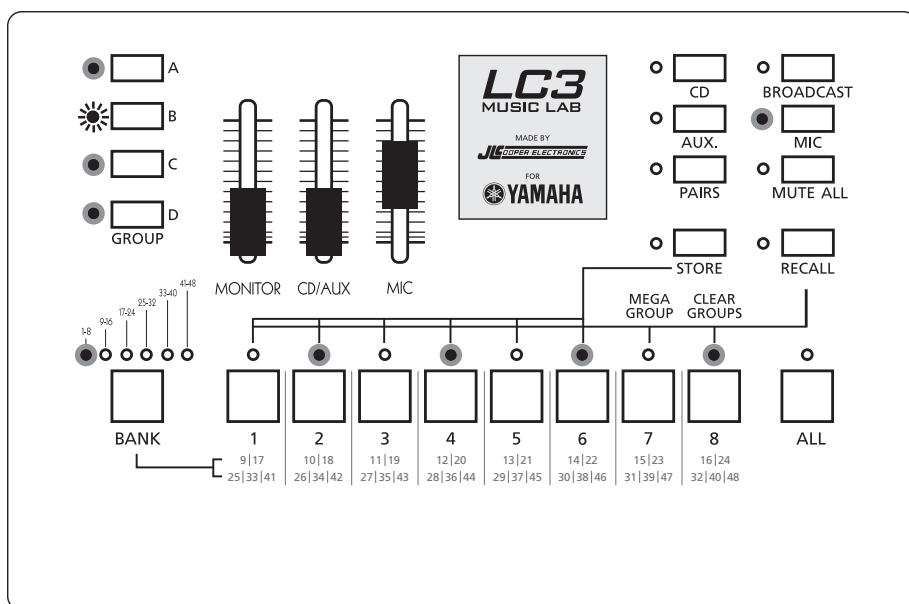

Example Four

You are working with GROUP C, which has a flashing light. A, B and D are working by themselves.

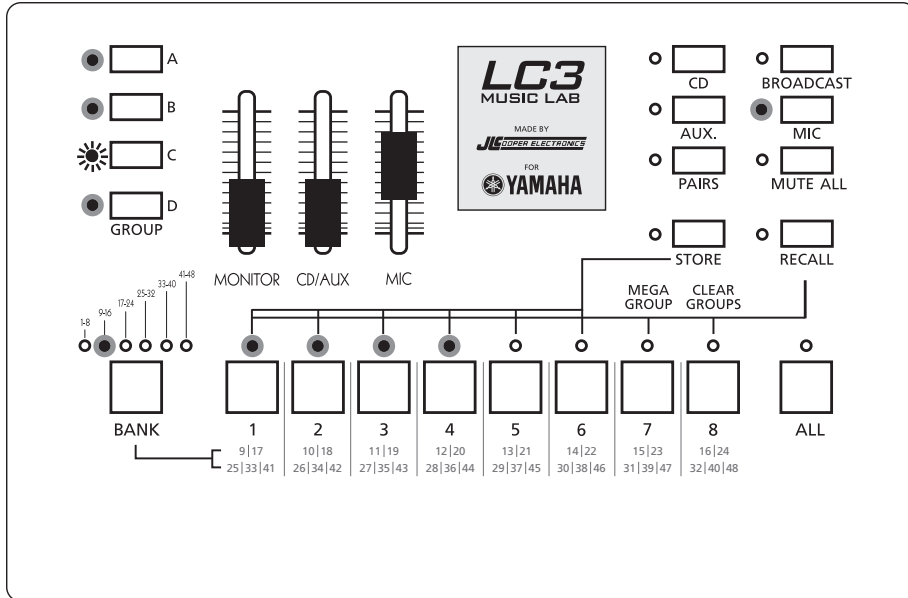

Example Five

You are working with GROUP D, which has a flashing light. A, B and C are working by themselves.

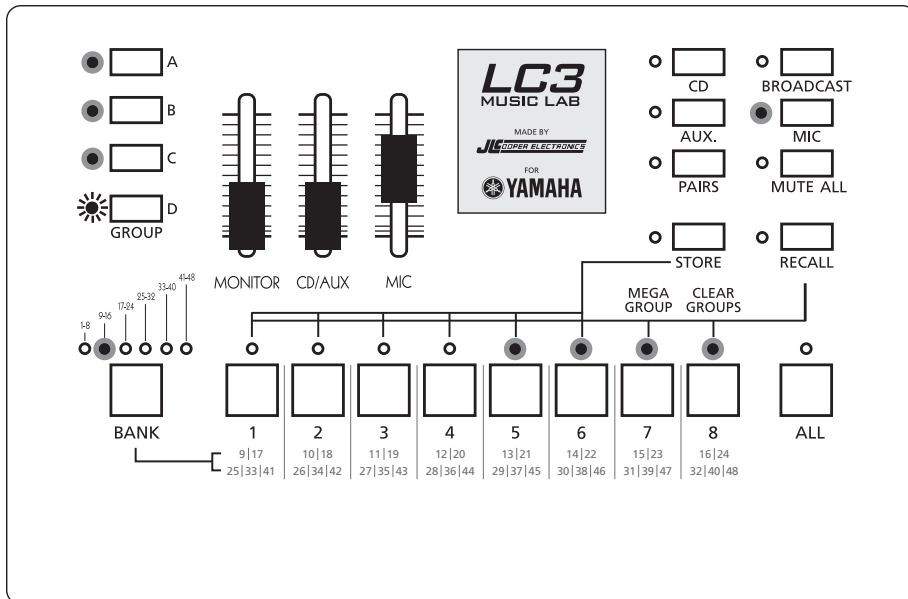

It's possible to group students from more than one bank—students 1 and 3 with student 10 and 11, for example. Simply press and hold the GROUP A button, select BANK 1, tap student 1 then 3, next select BANK 2 by pressing the BANK button and tap student number 10 (button 2) and 11 (button 3). Release the GROUP button A and it will begin to flash indicating the group is active and you are working with them.

Storing Custom Settings (RECALL MEMORY 1-6)

It's possible to save your GROUP A/B/C/D configurations as custom RECALL MEMORIES. Your control unit actually has six buttons—each capable of holding a GROUP A/B/C/D configuration. Remember that RECALL MEMORY 7 and RECALL MEMORY 8 are pre-set to turn all student buttons on (into a MEGAGROUP) and all student buttons off (students go back to the virtual practice rooms). RECALL MEMORIES 1-6 are yours to customize.

If you had six different classes, for example, you could have completely different GROUP A/B/C/D configurations for each class at the touch of a button.

To store your custom group settings in your control unit, first tap the STORE button, then tap the desired student button number 1-6.

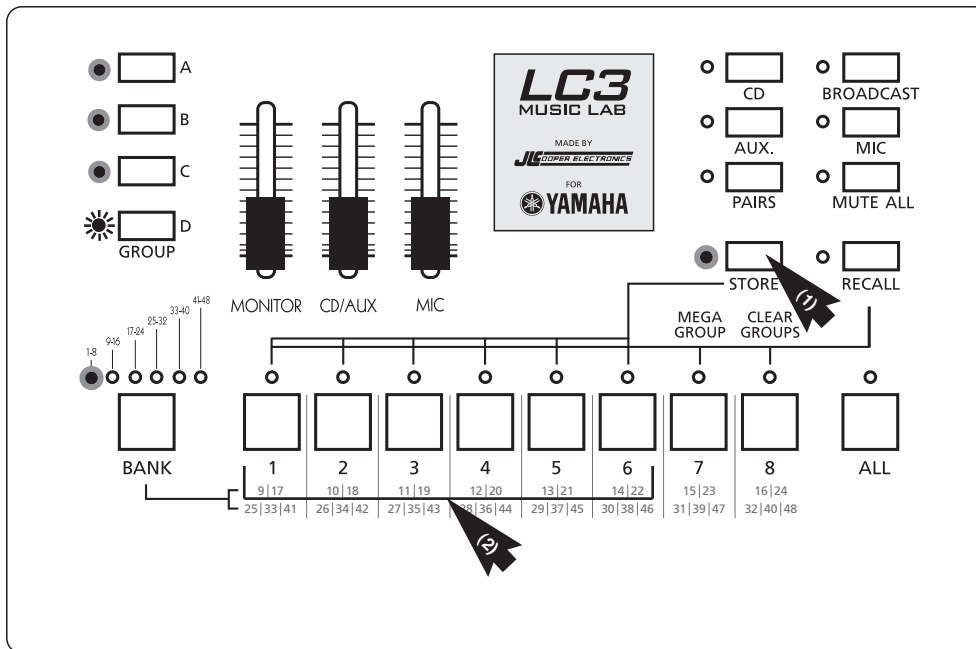

Tap one numbered button (1-6) to assign your RECALL MEMORY.

Recalling Custom Settings

To RECALL a memory, tap the RECALL button, then tap the button of the MEMORY desired.

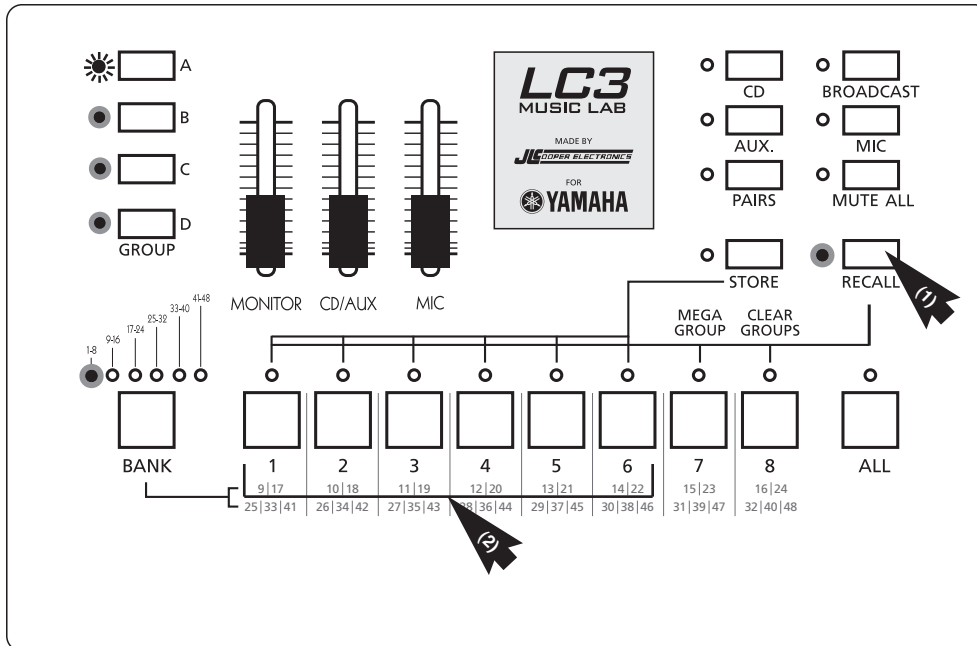

Tap one numbered button (1-6) to recall a preset you have stored.

Using a CD or MP3 Player

For the entire class to hear audio from a playback device, simply connect the audio player to the CD IN jack on the hub. Turn on the CD button from the control unit and move the CD/AUX slider up to desired volume. When the CD input is used, all students will hear the playback regardless of which student buttons are enabled. You can work with students or groups as described in the previous sections while providing CD/AUX audio to every student.

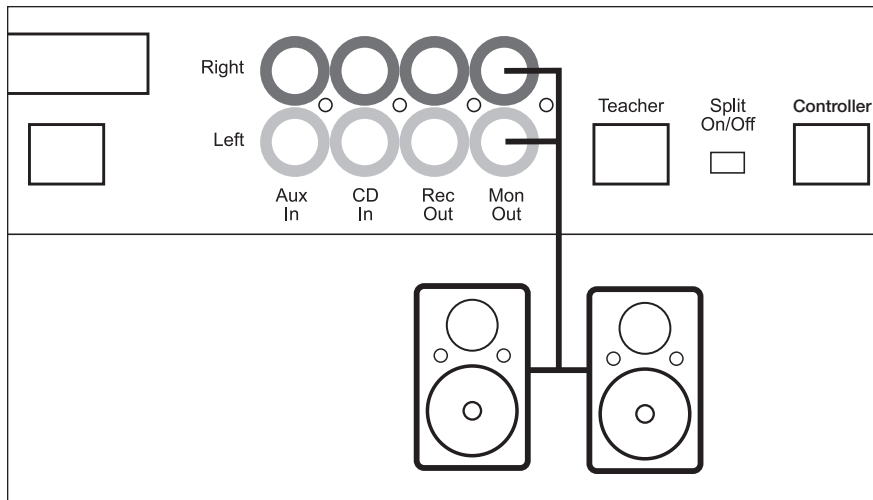

Recording a Student's Performance (Audio)

Connect a tape or CD recorder to the REC OUT on the hub. Then, to record the student, select the student, press RECORD on the recording device and tell the student to play. Anything you hear gets sent to the audio recorder.

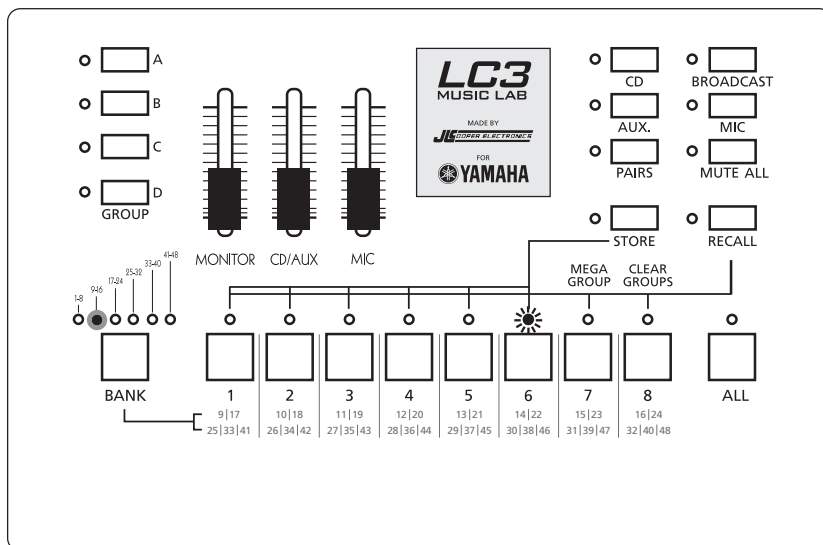

In this example, student 14 is being recorded.

Using External Powered Speakers

There might come a time when the audio in the LC3 lab needs to be heard by someone in the room who is not wearing headphones. With powered speakers (like a stereo system) connected to the MONITOR OUT of the hub, move the MONITOR slider up to volume desired.

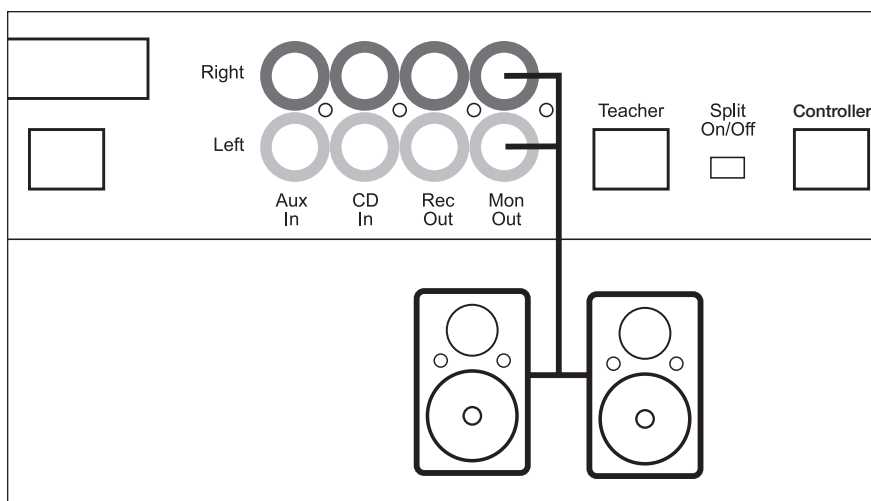

Using the AUX Input

For the entire class to hear audio from additional devices like MIDI file players, metronomes or computers, simply connect the device to the AUX IN jacks on the hub. Turn on the AUX button on the control unit and then move the CD/AUX slider up to desired volume. When the AUX input is used, all students will hear the device regardless of which student buttons are enabled. You can work with students or groups as described in the previous sections while providing CD/AUX audio to every student.

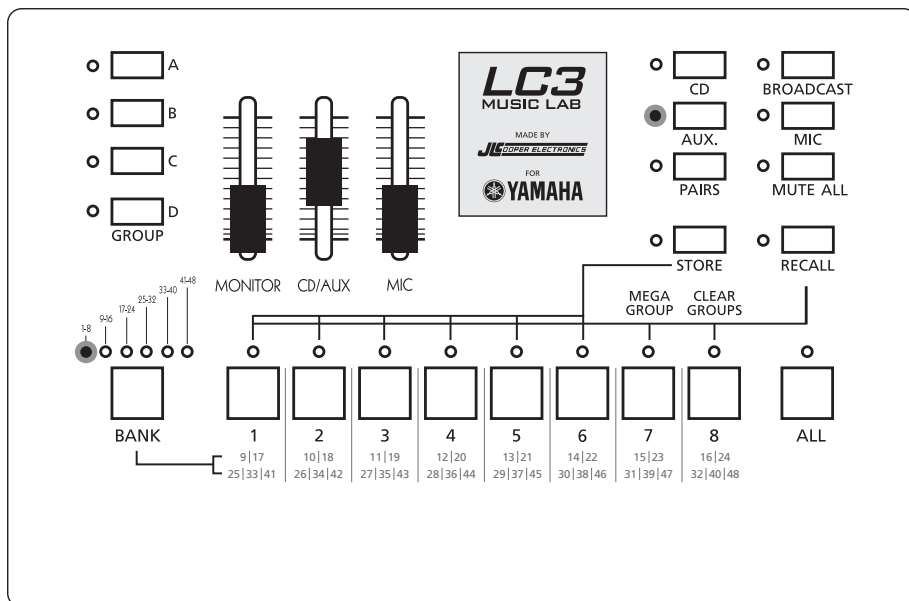



©2009 Yamaha Corporation of America. All rights reserved.
www.yamaha.com/LC3