



User's Manual

English

APC Smart-UPS[®]

1400VA XL 230VAC/120VAC/100VAC

3U Rack and Stack

Uninterruptible Power Supply

TABLE OF CONTENTS

1: Safety Information.....	1
Handling Safety.....	1
Electrical Safety.....	1
Deenergizing Safety.....	2
Battery Safety.....	2
2: Installation.....	3
Unpacking.....	3
Positioning the UPS.....	3
Installing the Smart-UPS.....	3
Accessories.....	7
3: Operation.....	8
Smart-UPS Front Panel.....	8
Smart-UPS Rear Panel.....	11
On Battery Operation.....	13
4: User Configurable Items.....	14
5: Transporting Your Smart-UPS.....	16
Disconnecting the Battery for Transport.....	16
Removing the UPS from the Rack.....	16
6: Storage and Maintenance.....	17
Storage.....	17
Replacing the Battery Module.....	17
7: Troubleshooting.....	19
Service.....	21
Contacting APC.....	21
8: Regulatory and Warranty Information.....	22
Regulatory Agency Approvals and Radio Frequency Warnings.....	22
Declaration of Conformity.....	23
Limited Warranty.....	23

Entire contents copyright © 2001 by American Power Conversion Corporation. All rights reserved. Reproduction in whole or in part without permission is prohibited.

APC, Smart-UPS, and PowerChute are registered trademarks of American Power Conversion Corporation. All other trademarks are the property of their respective owners.

1: SAFETY INFORMATION

American Power Conversion Corporation (APC) is the leading national and international manufacturer of state-of-the-art uninterruptible power supplies, redundant switches, power management software, and related equipment. APC products protect hardware, software, and data from the threat of power disturbances in business and government offices throughout the world.

The APC Uninterruptible Power Supply (UPS) is designed to prevent blackouts, brownouts, sags, and surges from reaching your computer and other valuable electronic equipment. The UPS filters out small utility line fluctuations and isolates your equipment from large disturbances by internally disconnecting from the utility line. The UPS provides continuous power from its internal battery until the utility line returns to safe levels.

	Changes or modifications to this unit not expressly approved by the party responsible for compliance could void the warranty.
---	--

HANDLING SAFETY

The UPS requires two people for installation due to its weight. To lighten the UPS, you may remove the battery while you position it.

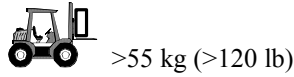
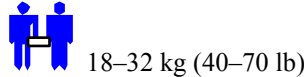
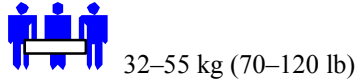
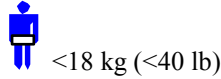





This equipment is intended for installation in a temperature-controlled indoor area free of conductive contaminants. Refer to *Specifications* at the APC web site www.apc.com/support, for the actual temperature range.

ELECTRICAL SAFETY

- Do not work alone under hazardous conditions.
- The UPS should only be attached to a properly protected receptacle that matches the plug used on the UPS. Refer to *Specifications* at the APC web site, www.apc.com/support for specific plug ratings.
- A licensed electrician is required to change the plug on the UPS and to install permanently wired equipment.
- Check that the power cord(s), plug(s), and sockets are in good condition.
- When grounding, disconnect the equipment from the utility power outlet before installing or connecting to other equipment. Reconnect the power cord only after all connections are made.
- Use one hand, whenever possible, to connect or disconnect signal cables to avoid a possible shock from touching two surfaces with different electrical grounds.
- Connect the equipment to a three wire utility outlet (two poles plus ground). The receptacle must be connected to appropriate branch circuit/mains protection (fuse or circuit breaker). Connection to any other type of receptacle may result in a shock hazard.

- In order to maintain compliance with the EMC directive, output cords attached to the UPS should not exceed 10 meters in length.
- Pluggable equipment includes a protective earth conductor that carries the leakage current from the load devices (computer equipment). Total leakage current must not exceed 3.5 mA.

DEENERGIZING SAFETY

- If the unit has an internal energy source (battery), the output may be energized when the unit is not connected to a utility power outlet.
- To deenergize **pluggable equipment**, press the  button for more than one second to switch the unit off. Disconnect the unit from the utility power outlet. Disconnect the battery. Push the  button to deenergize the capacitors.
- To deenergize **permanently wired equipment**: set the power switch to standby .
Set the utility circuit breaker to standby , and then disconnect the batteries (including any expansion units). Finally, disconnect the utility power from the building power supply.



Avoid using extension cords and adapter plugs.



Use of this equipment in life support applications where failure of this equipment can reasonably be expected to cause the failure of the life support equipment or to significantly affect its safety or effectiveness is not recommended.

BATTERY SAFETY

- This equipment contains potentially hazardous voltages. Do not attempt to disassemble the unit. The only exception is for equipment containing batteries. Battery replacement using the procedures below is permissible. Except for the battery, the unit contains no user serviceable parts. **Repairs are to be performed only by factory trained service personnel.**
- Do not dispose of batteries in a fire. The batteries may explode.
- Do not open or mutilate batteries. They contain an electrolyte that is toxic and harmful to the skin and eyes.
- To avoid personal injury due to energy hazard, remove wristwatches and jewelry such as rings when replacing the batteries. Use tools with insulated handles.
- Replace batteries with the same number and type of batteries or battery packs as originally installed in the equipment.

2: INSTALLATION

The UPS has a “rack and stack” design that provides two mounting options. The UPS can be mounted in a 46.5 cm (19-inch) equipment rack or stacked on a battery pack(s) model SU24RMXLBP2U. Hardware is provided for either option.

UNPACKING

Inspect the UPS upon receipt. APC designed robust packaging for your product. However, accidents and damage may occur during shipment. Notify the carrier and dealer if there is damage.

The packaging is recyclable; save it for reuse or dispose of it properly.

Check the package contents. The package contains the UPS (with battery disconnected), the front bezel, and a literature kit containing one CD, one serial cable, and product documentation. The package will also include a mounting kit with brackets, cleats, feet, and hardware, and a rail kit (necessary for rack mounting the UPS), containing mounting rails, installation instructions, and a hardware packet.

230V models have one power cord included with the literature kit.



The UPS is shipped with the battery and the front bezel disconnected. You will connect the battery and install the bezel during the installation procedure (described later).

POSITIONING THE UPS

Place the rack and the UPS where they will be used for either rack mounting or stacking. (Both procedures are detailed on the following pages.) **The UPS is heavy. Select a location sturdy enough to handle the weight.**

You must install the UPS in a protected area that is free of excessive dust and has adequate airflow. Ensure the air vents on the front and rear of the UPS are not blocked.

Do not operate the UPS where the temperature and humidity are outside the specified limits. Refer to *Specifications* at the APC web site, www.apc.com/support.

PLACEMENT

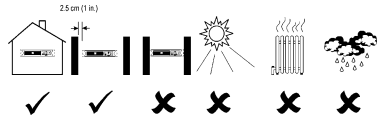

The diagram illustrates six placement scenarios for the UPS. From left to right: 1. A house icon with a checkmark below it, indicating a suitable location. 2. A rack icon with a dimension line showing 25 cm (1 in) and a checkmark below it, indicating a suitable location. 3. A sun icon with an X below it, indicating an unsuitable location due to excessive heat. 4. A fan icon with an X below it, indicating an unsuitable location due to dust. 5. A lightning bolt icon with an X below it, indicating an unsuitable location due to humidity. 6. A lightning bolt icon with an X below it, indicating an unsuitable location due to lightning strikes.

INSTALLING THE SMART-UPS

To install the Smart-UPS, follow these basic steps. Details are provided on the following pages.

1. Stack the UPS on the battery pack *or* install the mounting rails in the rack (four-post rack installation only). Place the UPS in the rack. **Install the UPS at or near the bottom of the rack.**
2. Connect the battery and attach the front bezel.
3. Connect the equipment and power to the UPS.
4. Turn on the UPS.
5. Install optional software and accessories.

STACKING THE UPS ON A BATTERY PACK

Note: For rack mounting, proceed to *Mounting the UPS in a Rack*, below.



Do not step on the UPS. The UPS chassis is not designed to support additional weight.

When stacking the UPS with an external battery pack, position the UPS on top of the 2U battery pack. The top of the battery pack has indentations for proper placement of the feet on the bottom of the UPS.

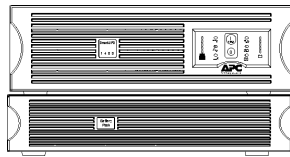
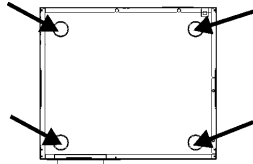

1. Unpack the four mounting feet shipped in the mounting kit.
2. Turn the UPS on its side so the bottom surface is accessible.
3. Locate the indentations on the bottom of the UPS that mark the foot positions (indicated by arrows in the figure at left).
4. Peel away the protective film on the back of one foot, align the adhesive side with an indentation on the UPS, and press hard to affix the foot to the UPS. Repeat this step for all feet.
5. Turn the UPS right side up and place it either on the floor or on an optional battery pack (shown). The battery pack cover has indentations to accommodate the feet on the bottom of either a UPS or another battery pack.
6. Continue with *Connecting the Battery and Attaching the Bezel* (next page).

MOUNTING THE UPS IN A RACK

The UPS comes with standard 19-inch (46.5 cm) rack mounting rails, brackets, and cleats. The rack can have any of the common types of equipment mounting holes (square, round-threaded, or round-non-threaded). All necessary hardware is provided.

The UPS is heavy. To lighten it, you may remove the battery before mounting the unit in the rack. See *Chapter 5, Removing the Bezel and Battery Module*. If you do not want to remove the battery, continue with *Mount the UPS in a Rack* (below).

Mount the UPS in a Rack

1. Install the mounting rails in the rack (required for four-post racks only). Directions are included with the rail kit.
2. For a four-post rack, attach a mounting cleat to each side of the UPS.

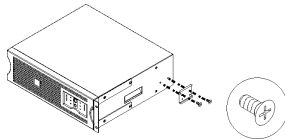

- Attach the mounting brackets to the UPS before mounting the UPS in your rack, (below). Each mounting bracket attaches to the UPS with four screws (included). Two sets of bracket holes are located on the sides of the UPS.

If you are using a four-post rack, attach the mounting brackets in the forward position. For two post rack mounting attach the brackets at the mid-point position.

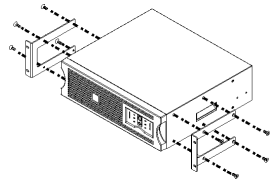

**Four-Post Rack
Bracket Position**

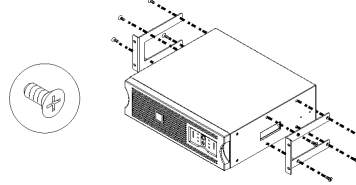

**Two-Post Rack
Bracket Position**

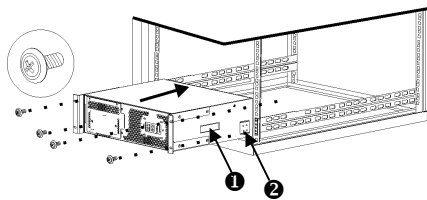

- Use the handles ❶ on the side of the UPS to support the unit.
Due to the weight of the UPS, two people are required to install it in the rack.
- Each side of the UPS has a cleat ❷ that must slide into the groove on the rails in four-post rack mounting. Slide the UPS into position.
- Use the four ornamental screws supplied with the UPS to attach the mounting brackets to the rack post in both two and four post mounting.



Check the rack to make sure it will not tip after loading the UPS into the rack.

Reinstalling the Battery

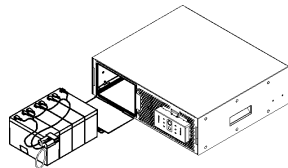

If you removed the battery before mounting the UPS in the rack, follow this step to reinstall it.

Supporting the battery on the bottom, align it with the battery door opening and slide it into the compartment.

CONNECTING THE BATTERY AND ATTACHING THE FRONT BEZEL

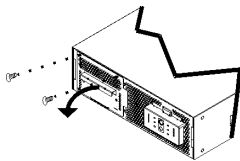

The battery is accessible from the front of the UPS. This procedure requires a Phillips head screwdriver.

- Use a screwdriver to remove the two battery door screws and open the door.

Set the screws aside. You will replace them later.

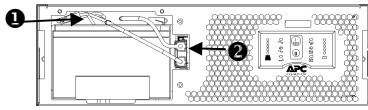

2. Locate the battery cables tucked on top of the battery ❶.
3. Locate the UPS battery connector jack ❷ to the right of the battery tray.
4. To connect the battery cable plug to the battery jack, push the plug into the jack firmly to ensure a tight connection. You will hear a “snap” when the connector is seated properly.
5. Tuck the white cord and the battery cables into the space above the UPS battery.
6. Close the battery door and replace the screws.
7. Unpack the bezel and hold it with the cutout section on the right. Align the tabs on the side of the bezel with the slots on the front of the UPS and gently snap it into place.

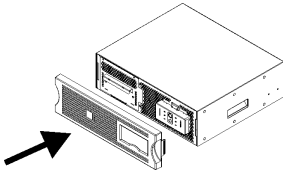

To connect an optional external battery pack(s) to the UPS, refer to the *2U Battery Pack User's Manual* for instructions. The Smart-UPS 1400 XL can support a maximum of ten external battery packs, model SU24RMXLBP2U.

CONNECTING EQUIPMENT AND POWER TO THE UPS



Avoid using extension cords and adapter plugs.



Do not connect a laser printer to the UPS. A laser printer draws significantly more power than other types of equipment and may overload the UPS.

1. Connect equipment to the UPS.
2. Connect the UPS to the utility power supply.
 - *230V models:* Plug the UPS into a two-pole, three-wire, grounding receptacle only. Your UPS is not supplied with an input line cord. Three output line cords are supplied for connecting equipment. Additional cords are available from your dealer.
 - Swap an input cord from another piece of equipment with one of the supplied output cords. The input cord used for the UPS must be three conductor—1.0 mm², rated 10 Amps. Plug this equipment input line cord into the inlet on the rear panel of the UPS and then into utility power. If your equipment does not have a removable line cord, see your dealer or contact APC at www.apc.com/support/contact, to obtain a suitable input line cord.
 - *120V/100V models:* The power cord is permanently attached to the rear panel of the UPS. Connect the ground lead to the TVSS screw located on the rear panel. Refer to *TVSS Screw* under *Smart-UPS Rear Panel* in *Chapter 3*. The transient voltage surge suppression (TVSS) screw provides grounding through the UPS power cord ground conductor. To make the

connection, loosen the screw and connect the surge suppression device ground lead. Tighten the screw to secure the lead.

- *100V models:* In order to operate at the full VA rating of the 1400VA product, the supplied 15A plug must be replaced with a 20A plug. This change must be done by qualified service personnel. Refer to the web site, www.apc.com/support for additional information.
3. Turn on all connected equipment. To use the UPS as a master ON/OFF switch, be sure all connected equipment is switched ON. The equipment will not be powered until the UPS is turned on.

TURNING ON THE UPS

1. Make sure the battery is connected before turning on the UPS! Press the  button on the front panel to power up the UPS. This will power up connected equipment. Make sure connected equipment is switched to the ON position.



The UPS charges its battery when it is connected to utility power. The battery charges fully during the first 24 hours of normal operation. **Do not** expect full battery run capability during this initial charge period.

The unit performs a self-test automatically when turned on and every two weeks thereafter (by default). Refer to the *User Configurable Items* in *Chapter 4*, for details on changing the default interval.

2. *120V models:* Check the site wiring fault LED located on the rear panel. It lights up if the UPS is plugged into an improperly wired utility power outlet. Wiring faults detected include missing ground, hot-neutral polarity reversal, and overloaded neutral circuit.



If the UPS indicates a site wiring fault, get a qualified electrician to correct the building wiring.

OPTIONAL ACCESSORIES

Add any optional accessories. See the documentation accompanying the accessory for details. See the APC web site, www.apc.com for available accessories.

ACCESSORIES

If the UPS is equipped with an accessory slot, visit the APC web site, www.apc.com, for available accessories.

If a standard accessory (such as an SNMP card) is installed on this UPS, see the Utility CD for user documentation.

For additional computer system security, install PowerChutePlus[®] Smart-UPS monitoring software. This provides automatic unattended shutdown capabilities on most major network operating systems.

3: OPERATION

SMART-UPS FRONT PANEL

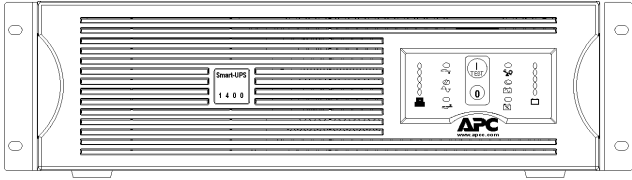

OPERATION

The ON and OFF buttons are used to power the UPS and act as master controls for the connected equipment. Make sure connected equipment is switched to the ON position. The UPS remains on as long as it is attached to utility power.

Power On



Press and release the  button to supply power to the UPS and connected equipment. The equipment is immediately powered and the UPS performs a self-test.

Power Off



Press and release the  button to turn off power to the UPS and connected equipment.

Load

0 85%

0 67%

0 50%

0 33%

0 17%



The five-LED display on the left of the front panel shows the percentage of available power used by the connected equipment. For example, if three LEDs are lit, the connected load is drawing between 50% and 67% of the UPS capacity. If all five LEDs are lit, the connected load is drawing between 85% and 100% of capacity. Thoroughly test your entire system to make sure that the UPS will not become overloaded. In the graphic to the left, the load capacity threshold is listed next to the LED (values are not listed on the UPS).

SELF-TEST

Automatic Self-Test

The UPS performs a self-test automatically when turned on, and every two weeks thereafter (by default). Refer to *User Configurable Items* for details on changing the default interval.

Automatic self-test eases maintenance requirements by eliminating the need for periodic manual self-tests. During the self-test, the UPS briefly operates the connected equipment on battery. If the UPS passes the self-test, it returns to online operation.

If the UPS fails the self-test, the UPS lights the *replace battery*

LED  and immediately returns to online operation. The connected equipment is not affected by a failed test. Recharge the battery for 24 hours and perform another self-test. If it fails, the battery must be replaced.

Manual Self-Test

Press and hold the  button for a few seconds to initiate the self-test.

UTILITY POWER

During normal operation, the UPS monitors the utility power and delivers power to the connected equipment. If your system is experiencing excessive periods of high or low voltage, have a certified electrician check your facility for electrical problems. If the problem continues, contact the utility company for further assistance.

Online



The online LED illuminates when the UPS is supplying utility power to the connected equipment. If the LED is not lit, the UPS is either not turned ON, or is supplying battery power. The UPS sounds an alarm—four beeps every 30 seconds.

Utility Voltage

230V	120V	100V
0264	0132	0117
0247	0123	0109
0230	0115	0101
0213	0107	092
0196	098	084



The UPS has a diagnostic feature that displays the utility voltage.

Plug the UPS into the normal utility power.

Press and hold the  button to view the utility voltage bar graph display. After a few seconds the five-LED display on the right of the front panel shows the utility input voltage. Refer to the figure at left for the voltage reading (values are not listed on the UPS).



The UPS starts a self-test as part of this procedure. The self-test does not affect the voltage display.

The display indicates the voltage is between the displayed value on the list and the next higher value. For example, with three LEDs lit on the 120V model, the input voltage is between 115 and 134 VAC.

If no LEDs are lit and the UPS is plugged into a working, utility power outlet, the line voltage is extremely low.

If all five LEDs are lit, the line voltage is extremely high and should be checked by an electrician.

AVR Trim

This LED illuminates to indicate the UPS is compensating for a high utility voltage.

AVR Boost

This LED illuminates to indicate the UPS is compensating for a low utility voltage.

BATTERY POWER

If the utility power fails, the UPS can provide power to the connected equipment from its internal battery for a finite period. The UPS sounds an alarm—four beeps every 30 seconds—while operating on battery power. The alarm stops when the UPS returns to online operation.

On Battery

When the *on battery power* LED is lit the UPS is supplying battery power to the connected equipment.

Battery Charge

○ 100%

○ 80%

○ 60%

○ 40%

○ 0%



The five-LED display on the right of the front panel shows the present charge of the UPS battery as a percentage of the battery capacity.

When all five LEDs are lit, the battery is fully charged. The LEDs extinguish, from top to bottom, as the battery capacity diminishes. Refer to the figure at left for the battery capacity threshold (values are not listed on the UPS).

As a low battery warning, any LEDs illuminated (for the given capacity) flash and the UPS beeps. The low battery warning default setting can be changed from the rear panel or through the optional Power-Chute software. Refer to Default Settings below for details.

Overload

The UPS emits a sustained alarm tone and the LED illuminates when an overload condition occurs. Refer to *Troubleshooting* in this manual.

Replace Battery

Failure of a battery self-test causes the UPS to emit short beeps for one minute and the *replace battery* LED illuminates. Refer to *Troubleshooting* in this manual.

SHUTDOWN MODE (VIA SOFTWARE OR AN ACCESSORY)

In shutdown mode, the UPS stops supplying power to the connected equipment, waiting for the return of utility power. If there is no utility power present, external devices (such as servers) connected to the computer interface or the accessory slot can command the UPS to shut down. This normally is done to preserve battery capacity after the shutdown of protected servers. The UPS scrolls the front panel LEDs sequentially in shutdown mode.

SMART-UPS REAR PANEL

230V models

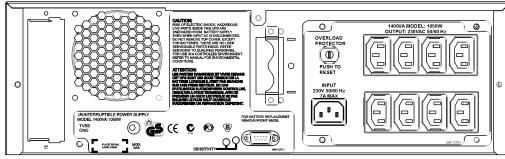

120V/100V models

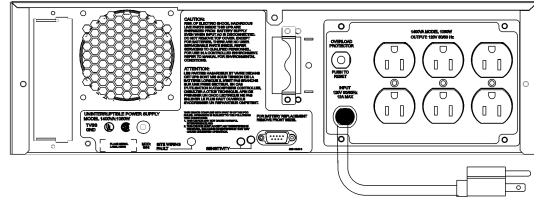

BASIC CONNECTORS

Serial Port



Power management software and interface kits can be used with the UPS. **Use only interface kits supplied or approved by APC.** If used, connect the interface cable to the 9-pin computer interface port. Secure the connector screws to complete the connection.



Use an APC supplied cable to connect to the Serial Port.

DO NOT use a standard serial interface cable since it is incompatible with the UPS connector.

If both Serial and USB Ports are provided they cannot be used simultaneously.



Use the battery pack connector to connect optional external battery pack(s). These units support up to ten external battery packs.

See the APC web site, www.apc.com/support for the correct external battery pack model number for your UPS.

TVSS Screw



120V/100V models only: The UPS features a transient voltage surge-suppression (TVSS) screw for connecting the ground lead on surge suppression devices such as telephone and network line protectors.

DEFAULT SETTINGS

Voltage Sensitivity



The UPS detects line voltage distortions (such as spikes, notches, dips, and swells) as well as distortions caused by operation with inexpensive fuel-powered generators. By default, the UPS reacts to distortions by transferring to on-battery operation to protect the connected equipment. Where power quality is poor, the UPS may frequently transfer to on-battery operation. If the connected equipment can operate normally under such conditions, reduce the sensitivity setting to conserve battery capacity and service life.

To reduce UPS sensitivity, press the *voltage sensitivity* button. Use a pointed object (such as a pen) to do so. Press the button once to set sensitivity to *medium*. Press it again to set sensitivity to *low*. Press the button a third time to reset to *high* sensitivity. You also can change the sensitivity level through software.



high



medium



low

Brightly lit: UPS is set to *high* sensitivity.

Dimly lit: UPS is set to *medium* sensitivity.

Off: UPS is set to *low* sensitivity.

Low Battery Warning Level

The low battery warning beeps to indicate low on-battery run time. It beeps periodically (approximately three times per minute) when less than seven minutes of run time remain. The beeps are continuous when only two minutes of run time remain.

This may not be enough time to shut down some protected computer systems. To change the warning interval default setting, press the *voltage sensitivity* button while pressing and holding the front-panel  button.



2 min.



5 min.



7 min.

Brightly lit: Low battery warning interval is about two minutes.

Dimly lit: Low battery warning interval is about five minutes.

Off: Low battery warning interval is about seven minutes.

FAULT LEDs

Input Circuit Breaker

If the plunger on the circuit breaker (located above the input cable connection) pops out, reduce the load on the UPS by unplugging equipment and press the plunger in.

Site Wiring Fault LED



120V models only: This LED lights up when the UPS is connected to an improperly wired utility power outlet. Refer to *Troubleshooting* in this manual.

ON BATTERY OPERATION

The Smart-UPS switches to battery operation automatically if the utility power fails. While running on-battery, an internal alarm sounds (periodic beeps).

Press the  button (front panel) to silence the UPS alarm (for the current alarm only). You can change the audible indicator if you are using the PowerChute software.

If the utility power does not return, the UPS continues to supply power to the connected equipment until exhausted. The UPS will begin to beep continuously approximately two minutes before the UPS final low battery shutdown. If using a computer, you must manually save your files and power down before the UPS turns off, unless you are using PowerChute interface software that provides automatic, unattended shutdown.

DETERMINING ON BATTERY RUN TIME

UPS battery life differs based on usage and environment. It is recommended that the battery/batteries are changed once every three years.

See the APC web site, www.apc.com, for on battery run times.

4: USER CONFIGURABLE ITEMS

NOTE: SETTING THESE ITEMS REQUIRES SOFTWARE OR OPTIONAL HARDWARE.			
<i>FUNCTION</i>	<i>FACTORY DEFAULT</i>	<i>USER SELECTABLE CHOICES</i>	<i>DESCRIPTION</i>
Automatic Self-Test	Every 14 days (336 hours)	Every 7 days (168 hours), On Startup Only, No Self-Test	This function sets the interval at which the UPS will execute a self-test. Refer to your software manual for details.
UPS ID	UPS_IDEN	Up to eight characters to define the UPS	Use this field to uniquely identify the UPS for network management purposes.
Date of Last Battery Replacement	Manufacture Date	Date of Battery Replacement	Reset this date when you replace the battery module.
Minimum Capacity Before Return from Shutdown	0 percent	15, 50, 90 percent	The UPS will charge its batteries to the specified percentage before return from a shutdown.
Sensitivity	High	Medium, Low	Set lower than <i>high</i> sensitivity to avoid lowered battery capacity and service life in situations where the connected equipment can tolerate minor power disturbances.
Duration of Low Battery Warning	2 minutes	5, 7, 10 minutes	This function sets the time before shutdown. The UPS issues a low battery warning. Set it higher than the default if the operating system needs more time for shutdown.
Alarm Delay After Line Fail	5 second delay	30 second delay at low battery condition only. No alarm for line fail.	To avoid alarms for minor power glitches, set the alarm delay.
Shutdown Delay	20 seconds	180, 300, 600 seconds	This function sets the interval between the time when the UPS receives a shutdown command and actual shutdown.
Synchronized Turn-on Delay	0 seconds	60, 180, 300 seconds	The UPS will wait the specified time after the return of utility power before turn-on (to avoid branch circuit overload).

NOTE: SETTING THESE ITEMS REQUIRES SOFTWARE OR OPTIONAL HARDWARE.			
FUNCTION	FACTORY DEFAULT	USER SELECTABLE CHOICES	DESCRIPTION
High Transfer Point	<p><i>230V models:</i> 253VAC</p> <p><i>120V models:</i> 132VAC</p> <p><i>100V models:</i> 110VAC</p>	<p><i>230V models:</i> 264, 271, 280VAC</p> <p><i>120V models:</i> 129, 135, 138VAC</p> <p><i>100V models:</i> 108, 112, 114VAC</p>	To avoid unnecessary battery usage, set the high transfer point higher if the utility voltage is chronically high and the connected equipment is known to work under this condition.
Low Transfer Point	<p><i>230V models:</i> 196VAC</p> <p><i>120V models:</i> 103VAC</p> <p><i>100V models:</i> 90VAC</p>	<p><i>230V models:</i> 188, 204, 208VAC</p> <p><i>120V models:</i> 97, 100, 106VAC</p> <p><i>100V models:</i> 81, 85, 92VAC</p>	Set the low transfer point lower if the utility voltage is chronically low and the connected equipment can tolerate this condition.
Output Voltage	<p><i>230V models:</i> 230VAC</p>	<p><i>230V models:</i> 220, 225, 240VAC</p>	<i>230V models only;</i> allow the user to select the output voltage.

5: TRANSPORTING YOUR SMART-UPS



Always **DISCONNECT THE BATTERY** before shipping in compliance with U.S. Department of Transportation (DOT) regulations.

The battery may remain in the UPS; it does not have to be removed.

DISCONNECTING THE BATTERY FOR TRANSPORT

The battery is accessible from the front of the UPS. This procedure requires a Phillips head screwdriver.

1. Shut down any equipment attached to the UPS.
2. Disconnect the UPS from the power supply.
3. Face the front of the UPS to remove the bezel. Use both hands and grasp the finger clips on either side of the bezel. Pull toward you. The bezel will unsnap.

Set the bezel aside.

4. Use a screwdriver to remove the two battery door screws and open the door.

5. To disconnect the battery, take out the white cord that is tucked into the space above the battery. This cord serves as a handle for the connector ❶. Grasp the cord and pull firmly toward you.

6. Tuck the white cord on top of the battery pack.

7. Close the battery door and replace the two screws removed in Step 4.

Leave the bezel off unless the UPS is being transported in a rack.

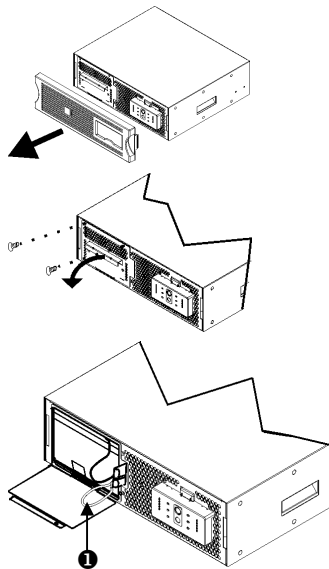

REMOVING THE UPS FROM THE RACK

If your UPS is mounted in a rack and you are removing it from the rack for transport:

- Remove the four ornamental screws that secure the unit to the rack. Refer to *Mounting the UPS in a Rack* in *Chapter 2*.
- Grasp the handle located on the front of the UPS and pull the unit halfway out of the rack.
- Use the handles on the sides of the unit for additional support and slide the unit out of the rack.

6: STORAGE AND MAINTENANCE

STORAGE

STORAGE CONDITIONS

Store the UPS covered and positioned as for proper functioning, in a cool, dry location, with its batteries fully charged. Disconnect any cables connected to the computer interface port to avoid unnecessary battery drainage.

EXTENDED STORAGE

At -15 to +30 °C (+5 to +86 °F), charge the UPS battery every six months.

At +30 to +45 °C (+86 to +113 °F), charge the UPS battery every three months.

REPLACING THE BATTERY MODULE

This UPS has an easy to replace, hot-swappable battery module. Replacement is a safe procedure, isolated from electrical hazards. You may leave the UPS and connected equipment on for the following procedure. See your dealer or contact APC at the web site, www.apc.com/support/contact, for information on replacement battery modules.

	Once the battery is disconnected, the connected equipment is not protected from power outages.
---	--

REMOVING THE FRONT BEZEL AND BATTERY MODULE

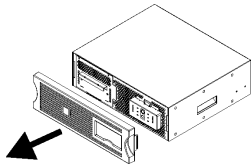

The battery module is accessible from the front of the UPS. This procedure requires a Phillips or straight head screwdriver.

1. Face the front of the UPS to remove the bezel. Use both hands and grasp the finger clips on either side of the bezel. Pull toward you. The bezel will unsnap. Set the bezel aside.

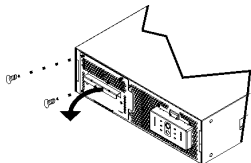

2. Use a screwdriver to remove the two battery door screws and open the door (hinged panel). Set the screws aside in a safe place. You will replace them later.

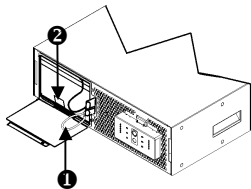

3. To disconnect the battery, take out the white cord that is tucked into the space above the battery. This cord serves as a handle for the connector ①. Grasp the cord and pull firmly toward you.
4. Be careful during this step—the battery module is heavy. Pull the battery module out of the UPS by pulling the clear label ②, *not* the white cord. (The battery module consists of a string of four batteries. The white cord is connected to the battery leads, not the body of the battery.)

REPLACING THE BATTERY MODULE

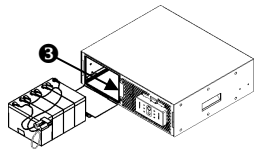



1. The plug on the new battery module is taped to the side of the battery. Remove this tape allowing the plug and the attached white cord and battery cables to come to the front of the battery.
2. Supporting the new battery module on the bottom, align it with the battery door opening and slide it into the compartment.
3. Locate the UPS battery connector jack ❸ to the right of the battery tray.
4. To connect the battery cable plug and the battery jack, push the plug into the jack firmly to ensure a tight connection. You will hear a “snap” when the connector is seated properly.
5. Tuck the white cord and the battery cables into the space above the UPS battery module.
6. Close the battery door and replace the two screws removed in Step 2.
7. Hold the bezel with the cutout section on the right. Align the tabs on the side of the bezel with the slots on the front of the UPS and gently snap it into place.



Be sure to return the spent battery to APC for recycling. Ship it to APC in the replacement battery packing material.

7: TROUBLESHOOTING

Use the chart below to solve minor Smart-UPS installation and operation problems. Refer to the APC web site, www.apc.com, for assistance with complex UPS problems.

PROBLEM AND POSSIBLE CAUSE	SOLUTION
UPS WILL NOT TURN ON	
 button not pushed. UPS not connected to utility power supply. UPS input circuit breaker tripped. Very low or no utility voltage. Battery not connected properly.	 button once to power the UPS and the connected equipment. Check that the power cable from the UPS to the utility power supply is securely connected at both ends. Reduce the load on the UPS by unplugging equipment and resetting the circuit breaker (on the back of UPS) by pressing the plunger in. Check the utility power supply to the UPS by plugging in a table lamp. If the light is very dim, have the utility voltage checked. Check that the battery connectors are fully engaged.
UPS WILL NOT TURN OFF	
Internal UPS fault.	Do not attempt to use the UPS. Unplug the UPS and have it serviced immediately.
UPS OPERATES ON BATTERY ALTHOUGH NORMAL LINE VOLTAGE EXISTS	
UPS input circuit breaker tripped. Very high, low, or distorted line voltage. Inexpensive fuel powered generators can distort the voltage.	Reduce the load on the UPS by unplugging equipment and resetting the circuit breaker (on the back of UPS) by pressing the plunger in. Move the UPS to a different outlet on a different circuit. Test the input voltage with the utility voltage display. If acceptable to the connected equipment, reduce the UPS sensitivity.
UPS BEEPS OCCASIONALLY	
Normal UPS operation.	None. The UPS is protecting the connected equipment.
UPS DOES NOT PROVIDE EXPECTED BACKUP TIME	
The UPS battery is weak due to a recent outage or is near the end of its service life.	Charge the battery. Batteries require recharging after extended outages. They wear faster when put into service often or when operated at elevated temperatures. If the battery is near the end of its service life, consider replacing the battery even if the <i>replace battery</i> LED is not yet lit.
ALL LEDs ARE LIT AND THE UPS EMITS A CONSTANT BEEPING	
Internal UPS fault.	Do not attempt to use the UPS. Turn the UPS off and have it serviced immediately.
The UPS is overloaded.	Check the UPS <i>Load</i> display. Unplug unnecessary equipment, such as printers.
FRONT PANEL LEDs FLASH SEQUENTIALLY	
The UPS has been shut down remotely through software or an optional accessory card.	None. The UPS will restart automatically when utility power returns.

PROBLEM AND POSSIBLE CAUSE	SOLUTION
ALL LEDs ARE OFF AND THE UPS IS PLUGGED INTO A WALL OUTLET	
The UPS is shut down and the battery is discharged from an extended outage.	None. The UPS will return to normal operation when the power is restored and the battery has a sufficient charge.
THE REPLACE BATTERY LED IS LIT	
<p>Weak battery.</p> <p>Replace Battery LED flashes and short chirp is emitted every two seconds to indicate the battery is disconnected.</p> <p>Failure of a battery self-test.</p>	<p>Allow the battery to recharge for at least 24 hours. Then, perform a self-test. If the problem persists after recharging, replace the battery.</p> <p>Check that the battery connectors are fully engaged.</p> <p>The UPS emits short beeps for one minute and the <i>replace battery</i> LED illuminates. The UPS repeats the alarm every five hours. Perform the self-test procedure after the battery has charged for 24 hours to confirm the <i>replace battery</i> condition. The alarm stops if the battery passes the self-test.</p>
THE OVERLOAD LED IS LIT AND THE UPS EMITS A SUSTAINED ALARM TONE	
The UPS is overloaded.	<p>The connected equipment exceeds the specified “maximum load” as defined in <i>Specifications</i> at the APC web site, www.apc.com.</p> <p>The alarm remains on until the overload is removed. Disconnect nonessential equipment from the UPS to eliminate the overload.</p> <p>The UPS continues to supply power as long as it is online and the circuit breaker does not trip; the UPS will not provide power from batteries in the event of a utility voltage interruption.</p> <p>If a continuous overload occurs while the UPS is on battery, the unit turns off output in order to protect the UPS from possible damage.</p>
THE SITE WIRING FAULT LED IS LIT	
The site wiring LED is lit.	The UPS is plugged into an improperly wired utility power outlet. Wiring faults detected include missing ground, hot-neutral polarity reversal, and overloaded neutral circuit. Contact a qualified electrician to correct the building wiring.
THERE IS NO UTILITY POWER AND THE UPS HAS BEEN TURNED OFF	
When the UPS is off and there is no utility power, use the cold start feature to apply power to the connected equipment from the UPS battery. Cold start is not a normal condition.	<p><i>230V/120V models Only:</i></p> <p>Press and hold the  button, (for about 3 seconds). The unit will beep, the LED lights will flash, and the unit will beep a second time. Release the ON button during the second beep. This will supply immediate power to the UPS and the connected equipment. Make sure connected equipment is switched to ON.</p>

SERVICE

If the UPS requires service do not return it to the dealer. Instead, follow these steps:

1. Review the problems discussed in the *Troubleshooting* section of this manual to eliminate common problems.
2. Verify that no circuit breakers are tripped.
3. If the problem persists, contact APC Customer Service through the APC web site, www.apc.com/support.
 - Note the model number of the UPS, the serial number, and the date purchased. If you call APC Customer Service, a technician will ask you to describe the problem and try to solve it over the phone, if possible. If this is not possible, the technician may arrange for the UPS to be serviced or may issue a Returned Material Authorization Number (RMA#).
 - If the UPS is under warranty, repairs are free. If not, there is a repair charge.
 - Procedures for servicing or returning your UPS may vary internationally. Please contact the APC Customer Service office in the appropriate country (www.apc.com/support) for questions about warranty and RMA.
4. Pack the UPS in its original packaging. If the original packing is not available, refer to the APC web site, www.apc.com/support, for information about obtaining a new set.
 - Pack the UPS properly to avoid damage in transit. Never use Styrofoam beads for packaging. Damage sustained in transit is not covered under warranty.



Always DISCONNECT THE BATTERY before shipping in compliance with U.S. Department of Transportation (DOT) regulations.

The battery may remain in the UPS; it does not have to be removed.

5. Mark the RMA# on the outside of the package.
6. Return the UPS by insured, prepaid carrier to the address given to you by Customer Service.

CONTACTING APC

Refer to the information provided at the APC Internet site,

<http://www.apc.com/support>.



If you ordered a Smart-UPS SU1400R3XLIX171 unit, please refer to the red addendum sheet (part number 990-1023A) for contact information.

8: REGULATORY AND WARRANTY INFORMATION

REGULATORY AGENCY APPROVALS AND RADIO FREQUENCY WARNINGS

230V MODELS



This is a Class A product. In a domestic environment this product may cause radio interference, in which case the user may be required to take corrective actions.

120V MODELS



120V STANDARD CLASS A MODELS

This equipment has been tested and found to comply with the limits for a Class A digital device, pursuant to part 15 of the FCC Rules. These limits are designed to provide reasonable protection against harmful interference when the equipment is operated in a commercial environment. This equipment generates, uses, and can radiate radio frequency energy and, if not installed and used in accordance with the instruction manual, may cause harmful interference to radio communications. Operation of this equipment in a residential area is likely to cause harmful interference in which case the user will be required to correct the interference at his own expense.

Shielded signal cables must be used with this product to ensure compliance with the Class A FCC limits.

120V STANDARD CLASS B MODELS

警告使用者:
這是甲類的資訊產品，在居住的環境中使用時，可能會造成射頻干擾，在這種情況下，使用者會被要求採取某些適當的對策。

100V MODELS



この装置は、情報処理装置等電波障害自主規制協議会（VCCI）の基準に基づくクラスA情報技術装置です。この装置を家庭環境で使用すると電波妨害を引き起こすことがあります。この場合には使用者が適切な対策を講ずるよう要求されることがあります。

DECLARATION OF CONFORMITY



2001

EC Declaration of Conformity

We, the undersigned, declare under our sole responsibility that the equipment specified below conforms to the following standards and directives:

Standards to Which Conformity Declared:	EN50091-1, EN60950, EN50091-1-1, IEC60950 EN55022, EN50091-2, EN61000-3-2, EN61000-3-3
Application of Council Directives:	73/23/EEC, 93/68/EEC 89/336/EEC, 92/31/EEC, 91/157/EEC
Type of Equipment:	Uninterruptible Power Supply
Model Numbers:	SU1400RMLI3U, SU1400R3XLIX171
Manufacturer's Name and Address:	American Power Conversion 132 Faingrounds Road West Kingston, Rhode Island, 02892, USA -or- American Power Conversion (A. P. C.) b. v. Ballybritt Business Park Galway, Ireland -or- American Power Conversion Main Avenue, Peza Rosario, Cavite, Philippines -or- American Power Conversion 2nd Street, Peza, Cavite Economic Zone Rosario, Cavite Philippines -or- American Power Conversion Lot 32 Phase 1 Carmelray Industrial Park Cantubang, Calamba, Laguna Philippines -or- APC (Suzhou) UPS Co., Ltd No. 189 Suhong Road, China-Singapore Suzhou Industrial Park Suzhou 215021, Jiangsu, P.R.C
Importer's Name and Address:	American Power Conversion (A. P. C.) b. v. Ballybritt Business Park Galway, Ireland
Place:	N. Billerica, MA U.S. <i>Richard J. Everett</i> 5 Jan 01 Richard J. Everett, Sr. Regulatory Compliance Engineer
Place:	Galway, Ireland <i>Ray S. Ballard</i> 5 Jan 01 Ray S. Ballard, Managing Director, Europe Phone: 353 917 02000 Fax: 353 9175 6909

LIMITED WARRANTY

American Power Conversion (APC) warrants its products to be free from defects in materials and workmanship for a period of two years from the date of purchase. Its obligation under this warranty is limited to repairing or replacing, at its own sole option, any such defective products. To obtain service under warranty you must obtain a Returned Material Authorization (RMA) number from customer support. Products must be returned with transportation charges prepaid and must be accompanied by a brief description of the problem encountered and proof of date and place of purchase. This warranty does not apply to equipment that has been damaged by accident, negligence, or misapplication or has been altered or modified in any way. This warranty applies only to the original purchaser who must have properly registered the product within 10 days of purchase.

EXCEPT AS PROVIDED HEREIN, AMERICAN POWER CONVERSION MAKES NO WARRANTIES, EXPRESSED OR IMPLIED, INCLUDING WARRANTIES OF MERCHANTABILITY AND FITNESS FOR A PARTICULAR PURPOSE. Some states do not permit limitation or exclusion of implied warranties; therefore, the aforesaid limitation(s) or exclusion(s) may not apply to the purchaser.

EXCEPT AS PROVIDED ABOVE, IN NO EVENT WILL APC BE LIABLE FOR DIRECT, INDIRECT, SPECIAL, INCIDENTAL, OR CONSEQUENTIAL DAMAGES ARISING OUT OF THE USE OF THIS PRODUCT, EVEN IF ADVISED OF THE POSSIBILITY OF SUCH DAMAGE. Specifically, APC is not liable for any costs, such as lost profits or revenue, loss of equipment, loss of use of equipment, loss of software, loss of data, costs of substitutes, claims by third parties, or otherwise.